

Data Sheet



Article number: 5725027215

Description: NSK Cirkular flange unit UCFC215D1

Measures

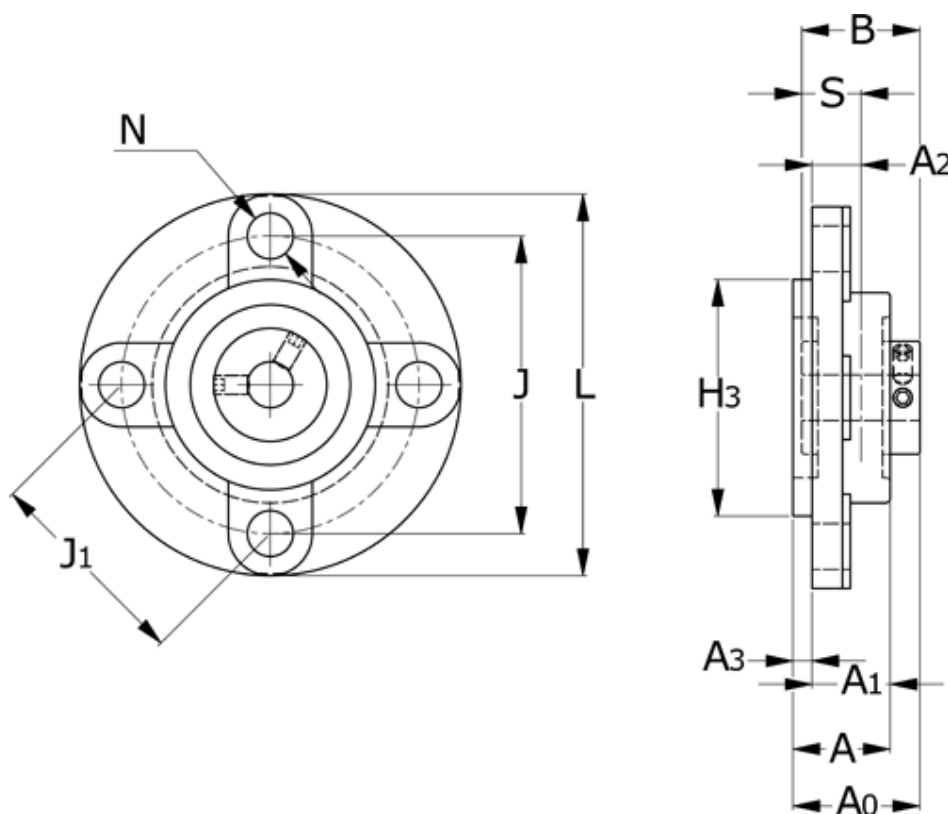

A = 56	J1 = 130.1
A0 = 78.5	L = 220
A1 = 40	N = 19
A2 = 18	S = 33.3
A3 = 16	Shaft = 75
B = 77.8	
H3 = 160	
J = 184	